

YDS-M6MPA-OV5640 V3.4

5MP OmniVision OV5640 MIPI- und DVP-Parallelschnittstelle Autofokus Kameramodul

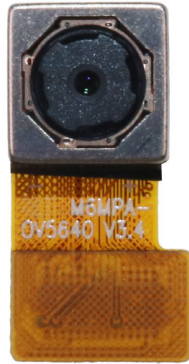

Vorderansicht

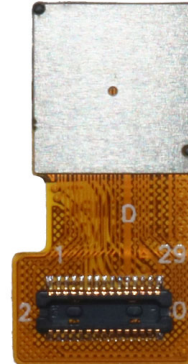

Rückansicht

Spezifikationen

Kameramodul Nr.	YDS-M6MPA-OV5640 V3.4
Auflösung	5MP
Bildsensor	OV5640
Sensorart	1/4"
Pixel Größe	1.4 um x 1.4 um
EFL	3.29 mm
F.NO	2.80
Pixel	2592 x 1944
Betrachtungswinkel	68.7°(DFOV) 58.1°(HFOV) 45.0°(VFOV)
Linsenabmessungen	8.50 x 8.50 x 5.07 mm
Modulgröße	19.00 x 9.60 mm
Modultyp	Autofokus
Schnittstelle	MIPI und DVP-Parallel
Autofokus-VCM-Treiber-IC	Eingebettet
Linsenmodell	YDS-LENS-M5101
Linsentyp	650 nm IR-Schnitt
Betriebstemperatur	-30°C to +70°C
Gegenstecker	DF30FC-30DS-0.4V

YDS-M6MPA-OV5640 V3.4

**5MP OmniVision OV5640 MIPI- und DVP-Parallelschnittstelle
Autofokus Kameramodul**

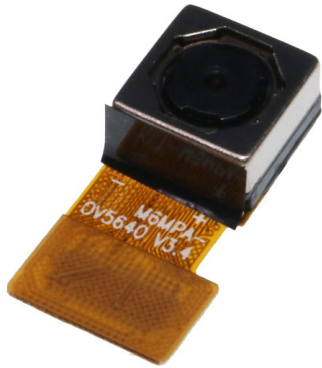

Ansicht von oben



Seitenansicht

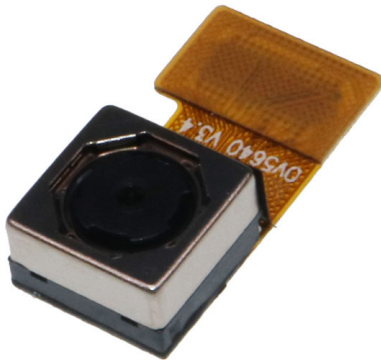

Untersicht



Gegenstecker

ROHS

PIN	SIGNAL
1	DO
2	AVDD2.8V
3	D1
4	AGND
5	D2
6	DVDD1.5V
7	D3
8	RESET
9	D4 / MDN0
10	DOVDD1.8V
11	D5 / MDP0
12	PWDN
13	D6 / MGN
14	SIO_C
15	D7 / MCP
16	SIO_D
17	D8 / MDN1
18	DGND
19	D9 / MDP1
20	VSYNC
21	DGND
22	HREF
23	XCLK
24	PCLK
25	DGND
26	DGND
27	AF_GND
28	STROBE
29	DGND
30	VAF_2.8V

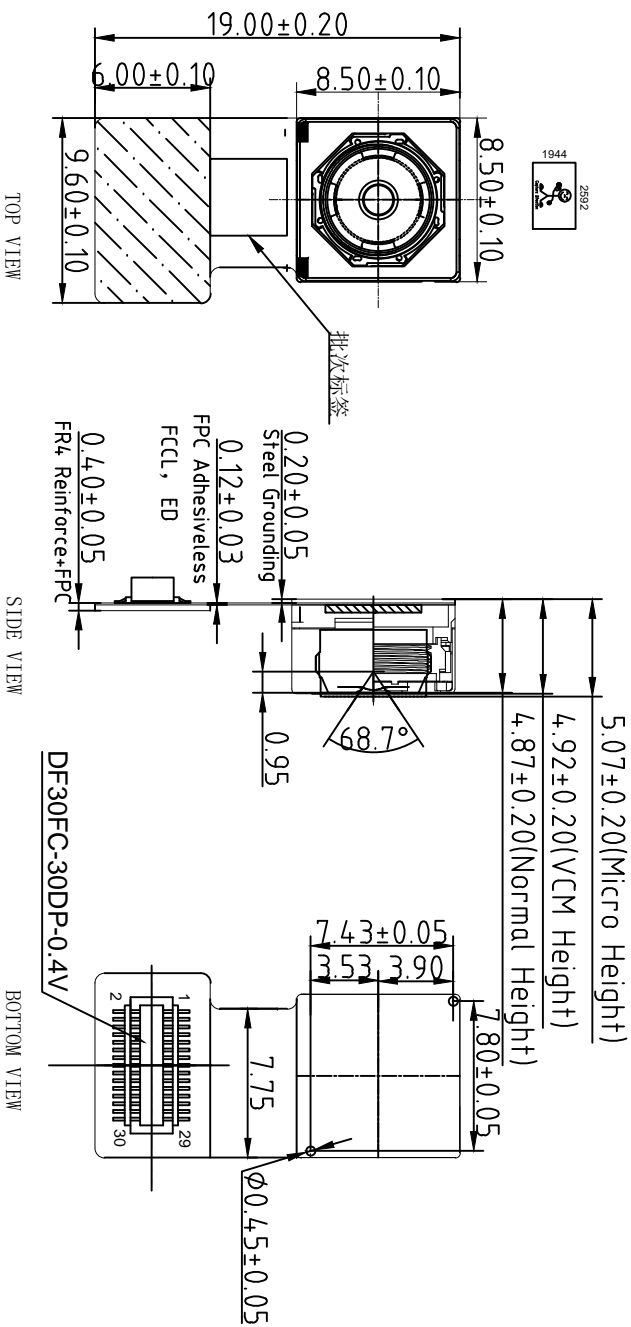

Parameters:

1、Sensor specification:

Image Sensor: OV5640
 Pixel: $1.4\mu\text{m} \times 1.4\mu\text{m}$
 Lens Type: 1/4
 Important Voltage Description: DVDD1.5V (external power supply);

2、Lens specification:

FOV: 68.7°
 F/NO.: 2.8
 TV distortion: $<1.0\%$
 Focal length: 3.29mm
 Composition: 4P+IR FILTER
 IR Cut Coating: $650\text{nm} \pm 10\text{nm} @ 50\%$

Version	Information	Date
V3.2	Change lens	8-20-2019
V3.4	Change VCM	8-12-2020

Designed By	Kevin	Model Name:	M6MPA-OV5640 V3.4
Checked By	Aouly Yan	Projection Type:	Third Angle
Unit:	mm	Scale:	1:1
Material:		Sheet:	1 of 1
Version:		Version:	1/0



OV5640 5-megapixel product brief



1/4-inch, 5-Megapixel SOC Image Sensor Optimized for High-Volume Mobile Markets



available in
a lead-free
package

The OV5640 delivers a complete 5-megapixel camera solution on a single chip, aimed at offering cost efficiencies that serve the high-volume autofocus (AF) camera phone market. The system-on-a-chip (SOC) sensor features OmniVision's 1.4 micron OmniBSI™ backside illumination architecture to deliver excellent pixel performance and best-in-class low-light sensitivity, while enabling ultra compact camera module designs of 8.5 mm x 8.5 mm with <6 mm z-height. The OV5640 provides the full functionality of a complete camera, including anti-shake technology, AF control, and MIPI while being easier to tune than two-chip solutions, making it an ideal choice in terms of cost, time-to-market and ease of platform integration.

The OV5640 enables 720p HD video at 60 frames per second (fps) and 1080p HD video at 30 fps with complete user control over formatting and output data transfer. The 720p/60 HD video is captured in full field of view (FOV) with 2 x 2 binning, which doubles the sensitivity and improves the signal-to-noise ratio (SNR). Additionally, a unique post-binning re-sampling filter function removes zigzag artifacts around slant edges and minimizes spatial artifacts to deliver even sharper, crisper

color images. To further improve camera performance and user experience, the OV5640 features an internal anti-shake engine for image stabilization, and it supports Scalado™ tagging for faster image preview and zoom.

The OV5640 offers a digital video port (DVP) parallel interface and a high-speed dual lane MIPI interface, supporting multiple output formats. An integrated JPEG compression engine simplifies data transfer for bandwidth-limited interfaces. The sensor's automatic image control functions include automatic exposure control (AEC), automatic white balance (AWB), automatic band filter (ABF), 50/60 Hz automatic luminance detection, and automatic black level calibration (ABLC). The OV5640 delivers programmable controls for frame rate, AEC/AGC 16-zone size/position/weight control, mirror and flip, cropping, windowing, and panning. It also offers color saturation, hue, gamma, sharpness (edge enhancement), lens correction, defective pixel canceling, and noise canceling to improve image quality.

Find out more at www.ovt.com.

Applications

- Mobile Phones
- Entertainment
- Digital Still and Video Cameras

Product Features

- 1.4 μm x 1.4 μm pixel with OmniBSI technology for high performance (high sensitivity, low crosstalk, low noise, improved quantum efficiency)
- optical size of 1/4"
- automatic image control functions:
 - automatic exposure control (AEC)
 - automatic white balance (AWB)
 - automatic band filter (ABF)
 - automatic 50/60 Hz luminance detection
 - automatic black level calibration (ABLCL)
- programmable controls for frame rate, AEC/AGC 16-zone size/position/weight control, mirror and flip, cropping, windowing, and panning
- image quality controls: color saturation, hue, gamma, sharpness (edge enhancement), lens correction, defective pixel canceling, and noise canceling
- support for output formats: RAW RGB, RGB565/555/444, CCIR656, YUV422/420, YCbCr422, and compression
- support for LED and flash strobe mode
- support for internal and external frame synchronization for frame exposure mode
- support horizontal binning and vertical sub-sampling
- support horizontal binning and vertical sub-sampling
- post binning resampling filter to minimize spatial/aliasing artifacts on 2x2 binned image
- embedded JPEG compression
- support for anti-shake
- digital video port (DVP) parallel output interface and dual lane MIPI output interface
- embedded 1.5V regulator for core power
- programmable I/O drive capability, I/O tri-state configurability
- support for black sun cancellation
- embedded arbitrary scalar supporting any size from 5 MP and below
- auto focus control (AFC) with embedded AF VCM driver
- embedded microcontroller
- suitable for module size of 8.5 x 8.5 x ~6mm with both CSP and RW packaging

OV5640

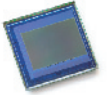

Ordering Information

- OV05640-A71A (color, lead-free, 71-pin CSP3)
- OV05640-G04A (color, chip probing, 200 μm backgrinding, reconstructed wafer)

Product Specifications

- active array size: 2592 x 1944
- power supply:
 - core: 1.5 V \pm 5% (with embedded 1.5 V regulator)
 - analog: 2.6 - 3.0 V (2.8 V typical)
 - I/O: 1.8 V / 2.8 V
- power requirements:
 - active: 140 mA
 - standby: 20 μA
- temperature range:
 - operating: -30°C to 70°C junction temperature
 - stable image: 0°C to 50°C junction temperature
- output formats: 8/10-bit RAW RGB output
- lens size: 1/4"
- lens chief ray angle: 24°
- input clock frequency: 6 - 27 MHz
- shutter: rolling shutter / frame exposure
- maximum image transfer rate:
 - QSXGA (2592x1944): 15 fps
 - 1080p: 30 fps
 - 1280 x 960: 45 fps
 - 720p: 60 fps
 - VGA (640x480): 90 fps
 - QVGA (320x240): 120 fps
- sensitivity: 600 mV/lux-sec
- maximum exposure interval: 1964 x t_{ROW}
- max S/N ratio: 36 dB
- dynamic range: 68 dB @ 8x gain
- pixel size: 1.4 μm x 1.4 μm
- dark current: 8 mV/sec @ 60°C junction temperature
- image area: 3673.6 μm x 2738.4 μm
- package dimensions:
 - CSP3: 5985 μm x 5835 μm
 - COB: 6000 μm x 5850 μm

Functional Block Diagram

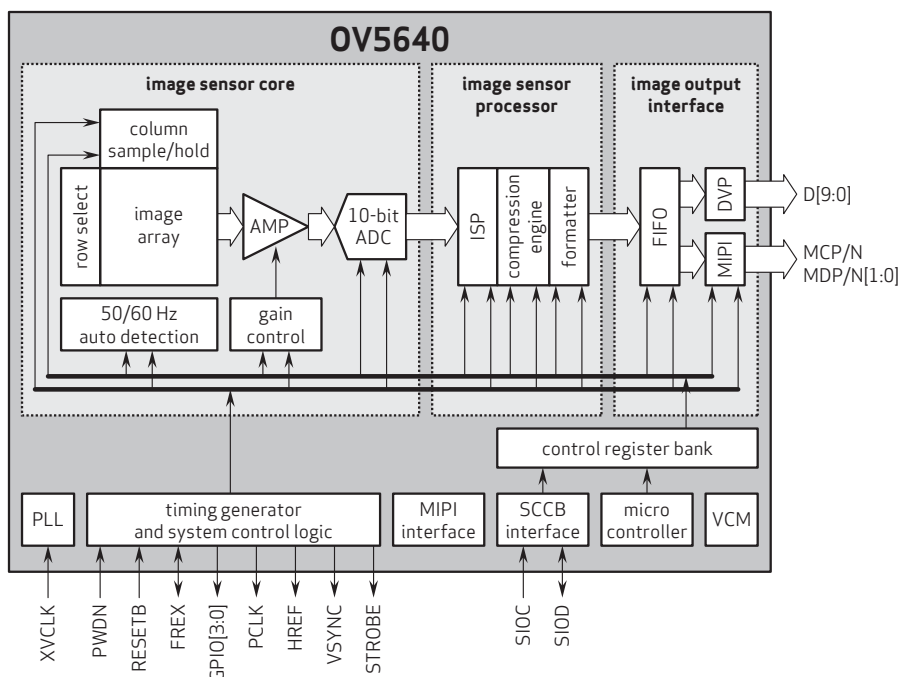

4275 Burton Drive
Santa Clara, CA 95054
USA

Tel: + 1 408 567 3000
Fax: + 1 408 567 3001
www.ovt.com

OmniVision reserves the right to make changes to their products or to discontinue any product or service without further notice. OmniVision, the OmniVision logo and OmniPixel are registered trademarks of OmniVision Technologies, Inc. OmniBSI is a trademark of OmniVision Technologies, Inc. All other trademarks are the property of their respective owners.

OmniVision

YDS-LENS-M5101

SPECIFICATION		
1. SENSOR SIZE	1/4" (5M CSP)	
2. MAX IMAGE CIRCLE	φ4.90mm	
3. TOTAL TRACK	4.18±0.1mm	
4. BFL	3.29mm	
5. OPTICAL BFL	1.43mm	
6. MECHANICAL BFL	0.85mm	
7. F/NO	2.8±5%	
8. VIEW OF FIELD	VERTICAL	45.0° (γ=1.36)
	HORIZONTAL	58.1° (γ=1.814)
	DIAGONL	68.7° (γ=2.268)
9. OPTICAL DISTORTION	<1.0%	
10. TV DISTORTION	<1.0%	
11. RELATIVE ILLUMINATION	>42.3%	
12. CONSTRUCTION	4F+IR FILTER	
13. CHIEF RAY ANGLE	<25°	
14. CUT FREQUENCY AT 50%	650±10nm	
15. THREAD	M6.0X0.35P	
16. IMAGE QUALITY	AXIS	330lp/mm
	0.7Y	200lp/mm
17. APPEARANCE QUALITY (Scratch/Di ₂)	CENTER	20/10
	EDGE	40/20

NO	MODIFY CONTENT	NAME	DATE	ANGLE	DIM	TYPE	UNIT	MATERIAL	SCALE	APPROVED BY	FINISH	DATE	LOCATION	REV
1									8 : 1			2013.05.03		A-00

NOTE:

- 镜头表面不可有油污、灰尘、毛丝等异物。
- 镜头配VCM锁附高度为 4.7±0.1mm, 扭力为20—60gf.cm。
- 镜头承受推力为≥2.0kg。
- 镜头品质参数需符合图中要求。

0.4 mm Pitch, 0.9 mm Height, Board-to-Board / Board-to-FPC Connectors

DF30 Series



Extremely small size



40 positions shown

Overview

Continuous miniaturization and increased component density on PCB created demand for extremely low profile connectors. This series is addition of a new extremely low profile connectors to Hirose's wide range of high reliability board-to-board/board-to-FPC connection solutions.

Features

1. Contact reliability

Concentration of the contact's normal forces at the single point assures good contact wipe and electrical reliability, while confirming the fully mated condition with a definite tactile click.

2. Self alignment

Recognizing the difficulties of mating extremely small connectors in limited spaces the connectors will self align in horizontal axis within 0.3 mm.

3. Automatic board placement

Packaged on tape-and-reel the plug and headers have sufficiently large flat areas to allow pick-up with vacuum nozzles of automatic placement equipment.

4. Variety of contact positions and styles

Available in standard contact positions of: 20, 22, 24, 30, 34, 40, 50, 60, 70 and 80 with and without metal fittings. Addition of metal fittings does not affect external dimensions of the connectors.

Smaller contact positions are also available.

5. Support for continuity test connector

Connectors which have increased insertion and removal durability are available for continuity tests. Contact your Hirose sales representative for details.

Applications

Cellular phones, PDA's, mobile computers, digital cameras, digital video cameras, and other devices demanding high reliability connections in extremely limited spaces.

Low profile

Increased mated retention

High contact reliability



Self alignment



Product Specifications

Rating	Rated current 0.3A	Operating temperature range : -35°C to 85°C (Note 1)	Storage temperature range -10°C to 60°C (Note 2)
	Rated voltage 30V AC	Operating humidity range : Relative humidity 20% to 80%	Storage humidity range Relative humidity 40% to 70% (Note 2)

Item	Specification	Conditions
1. Insulation resistance	50 MΩ min.	100V DC
2. Withstanding voltage	No flashover or insulation breakdown.	100V AC / one minute
3. Contact resistance	100 mΩ max.	100 mA
4. Vibration	No electrical discontinuity of 1 μs or more	Frequency: 10 to 55 Hz, single amplitude of 0.75mm, 2 hours, 3 axis
5. Humidity	Contact resistance: 100 mΩ max. Insulation resistance: 25 MΩ min.	96 hours at temperature of 40°C±2°C and RH of 90% to 95%
6. Temperature cycle	Contact resistance: 100 mΩ max. Insulation resistance: 50 MΩ min.	Temperature: -55°C→+5°C to +35°C→+85°C→+5°C to +35°C Duration: 30→10→30→10(Minutes) 5 cycles
7. Durability (insertions/withdrawals)	Contact resistance: 100 mΩ max.	50 cycles(Connector for conductivity tests: 500 cycles)
8. Resistance to soldering heat	No deformation of components affecting performance.	Reflow: At the recommended temperature profile Manual soldering: 300°C for 3 seconds

Note 1: Includes temperature rise caused by current flow.

Note 2: The term "storage" refers to products stored for long period of time prior to mounting and use. Operating temperature range and humidity range covers non-conducting condition of installed connectors in storage, shipment or during transportation.

Materials and Finishes

Connectors	Component	Material	Finish	Remarks
Receptacles and Headers	Insulator	LCP	Color : Black	UL94V-0
	Contacts	Phosphor bronze	Gold plated	————
	Metal fittings	Phosphor bronze	Tin-copper plated	————

Ordering information

Receptacles and Headers

DF30 **FC** - ***** **DS - 0.4** **V** **(**)**
① ② ③ ④ ⑤ ⑥ ⑦

① Series name: DF30	⑤ Contact pitch: 0.4 mm
② Configuration FB: With metal fittings, without bosses FC: Without metal fittings, without bosses CJ: Connector for conductivity tests	⑥ Termination section V: Straight SMT
③ Number of positions: 20, 22, 24, 30, 34, 40, 50, 60, 70, 80	⑦ Packaging (81): Embossed tape packaging (5,000 pieces per reel) (82): Embossed tape packaging (1,000 pieces per reel)
④ Connector type DS: Double row receptacle DP: Double row header	

■ Receptacles (without metal fittings)



◆ Recommended PCB mounting pattern



Recommended solder paste thickness: 120 μm

[Specification number] -**, (**)
(81): Embossed tape packaging (5,000 pieces per reel)

* Tolerances non- accumulative.

Unit: mm

Part Number	CL No.	Number of contacts	A	B	C
DF30FC-20DS-0.4V(**)	CL684-1109-8-**	20	6.22	3.6	1.2
DF30FC-22DS-0.4V(**)	CL684-1110-7-**	22	6.62	4.0	1.2
DF30FC-24DS-0.4V(**)	CL684-1111-0-**	24	7.02	4.4	1.2
DF30FC-30DS-0.4V(**)	CL684-1112-2-**	30	8.22	5.6	1.2
DF30FC-34DS-0.4V(**)	CL684-1113-5-**	34	9.02	6.4	1.36
DF30FC-40DS-0.4V(**)	CL684-1078-6-**	40	10.22	7.6	1.6
DF30FC-50DS-0.4V(**)	CL684-1114-8-**	50	12.22	9.6	2.0
DF30FC-60DS-0.4V(**)	CL684-1082-3-**	60	14.22	11.6	2.4
DF30FC-70DS-0.4V(**)	CL684-1115-0-**	70	16.22	13.6	2.8
DF30FC-80DS-0.4V(**)	CL684-1116-3-**	80	18.22	15.6	3.2

Note 1: Order by number of reels.

Note 2: Receptacles with 24 or fewer contacts positions will not have recessed areas.

Kameraanwendungen



Autopilot



Live-Streaming



Videokonferenz



Biometrische Eye-Tracker-Erkennung



Maschinelles Sehen



Agrarmonitor



Nachtsichtsicherheit



Drohnen- und Sport-Adleraugen



Interaktive Haustierkamera

Referenztable für die Pinbelegungsdefinition des Kameramoduls

OmniVision Sony Himax Samsung On-Semi Aptina Himax GalaxyCore PixArt Bildsensoren	
Pin Signal	Beschreibung
DGND GND	Masse für digitale Schaltung
AGND	Masse für analoge Schaltung
PCLK DCK	DVP-PCLK-Ausgang
XCLR PWDN XSHUTDOWN STANDBY	Abschalten aktiv hoch mit internem Pulldown-Widerstand
MCLK XVCLK XCLK INCK	Systemeingangsuhr
RESET RST	Aktiv Low mit internem Pull-up-Widerstand zurücksetzen
NC NULL	keine Verbindung
SDA SIO_D SIOD	SCCB-Daten
SCL SIO_C SOIC	SCCB-Eingangstakt
VSYNC XVS FSYNC	DVP-VSYNC-Ausgang
HREF XHS	DVP-HREF-Ausgang
DOVDD	Strom für E/A-Schaltung
AFVDD	Strom für VCM-Schaltung
AVDD	Strom für analoge Schaltung
DVDD	Strom für digitale Schaltung
STROBE FSTROBE	Strobe-Ausgang
FSIN	Synchronisieren Sie das VSYNC-Signal vom anderen Sensor
SID	SCCB letzte Bit-ID-Eingabe
ILPWM	mechanische Shutter-Ausgangsanzeige
FREX	Rahmenbelichtung / mechanischer Verschluss
GPIO	Allzweckeingänge
SLASEL	I2C-Slave-Adresse auswählen
AFEN	CEN-Chip aktivieren aktiv hoch auf VCM-Treiber-IC
MIPI Schnittstelle	
MDN0 DN0 MD0N DATA_N DMO1N	MIPI 1st negative Ausgabe der Datenspur
MDP0 DP0 MD0P DATA_P DMO1P	MIPI 1st positiver Ausgang der Datenspur
MDN1 DN1 MD1N DATA2_N DMO2N	MIPI 2nd negative Ausgabe der Datenspur
MDP1 DP1 MD1P DATA2_P DMO2P	MIPI 2nd positiver Ausgang der Datenspur
MDN2 DN2 MD2N DATA3_N DMO3N	MIPI 3rd negative Ausgabe der Datenspur
MDP2 DP2 MD2P DATA3_P DMO3P	MIPI 3rd positiver Ausgang der Datenspur
MDN3 DN3 MD3N DATA4_N DMO4N	MIPI 4th negative Ausgabe der Datenspur
MDP3 DP3 MD3P DATA4_P DMO4P	MIPI 4th positiver Ausgang der Datenspur
MCN CLKN CLK_N DCKN	MIPI Uhr negativer Ausgang
MCP CLKP MCP CLK_P DCKN	MIPI Takt positiver Ausgang
DVP Parallel Schnittstelle	
D0 DO0 Y0	DVP Datenausgabeport 0
D1 DO1 Y1	DVP Datenausgabeport 1
D2 DO2 Y2	DVP Datenausgabeport 2
D3 DO3 Y3	DVP Datenausgabeport 3
D4 DO4 Y4	DVP Datenausgabeport 4
D5 DO5 Y5	DVP Datenausgabeport 5
D6 DO6 Y6	DVP Datenausgabeport 6
D7 DO7 Y7	DVP Datenausgabeport 7
D8 DO8 Y8	DVP Datenausgabeport 8
D9 DO9 Y9	DVP Datenausgabeport 9
D10 DO10 Y10	DVP Datenausgabeport 10
D11 DO11 Y11	DVP Datenausgabeport 11

Kamera-Zuverlässigkeitstest

Zuverlässigkeitsprüfpunkt		Testmethode	Akzeptanzkriterium	
Kategorie	Artikel			
Umwelt	Lager Temperatur	Hoch 60°C 96 Std	Temperaturkammer	Keine anormale Situation
		Niedrig -20°C 96 Std	Temperaturkammer	Keine anormale Situation
	Betriebs Temperatur	Hoch 60°C 24 Std	Temperaturkammer	Keine anormale Situation
		Niedrig -20°C 24 Std	Temperaturkammer	Keine anormale Situation
	Feuchtigkeit	60°C 80% 24 Std	Temperaturkammer	Keine anormale Situation
	Thermischer Schock	Hoch 60°C 0.5 Std Niedrig -20°C 0.5 Std Radfahren rein 24 Std	Temperaturkammer	Keine anormale Situation
Physisch	Falltest (Im freien Fall)	Ohne Verpackung 60cm	10 Mal auf Holzboden	Elektrisch funktionsfähig
		Mit Paket 60cm	10 Mal auf Holzboden	Elektrisch funktionsfähig
	Vibrations Test	50Hz X-Axis 2mm 30 Minuten	Vibrationstisch	Elektrisch funktionsfähig
		50Hz Y-Axis 2mm 30 Minuten	Vibrationstisch	Elektrisch funktionsfähig
		50Hz Z-Axis 2mm 30 Minuten	Vibrationstisch	Elektrisch funktionsfähig
	Zugfestigkeit des Kabels Krafttest	Gewicht laden 4 kg 60 Sekunden Radfahren rein 24 Std	Zugprüfmaschine	Elektrisch funktionsfähig
Elektrisch	ESD-Test	Kontaktaufnahme 2 KV	ESD-Prüfmaschine	Elektrisch funktionsfähig
		Luftentladung 4 KV	ESD-Prüfmaschine	Elektrisch funktionsfähig
	Alterungstest	On/Off 30 Sekunden Radfahren rein 24 Std	Stromschalter	Elektrisch funktionsfähig
	USB-Anschluss	On/Off 250 Mal	Einstecken und ausstecken	Elektrisch funktionsfähig



Kamerainspektionsstandard

Inspektionsgegenstand		Untersuchungsmethode	Inspektionsstandard	
Kategorie	Artikel			
Aussehen	FPC oder PCB	Farbe	Das bloße Auge	Größere Unterschiede sind nicht zulässig.
		Zerrissen/gehackt werden	Das bloße Auge	Das Freilegen von Kupferrissen ist nicht zulässig.
		Markierung	Das bloße Auge	Klar, erkennbar (innerhalb von 30 cm Entfernung)
	Halterin	Kratzer	Das bloße Auge	Die Freilegung von Rissen im Inneren ist nicht zulässig
		Lücke	Das bloße Auge	Erfüllen Sie den Höhenstandard
		Schraube	Das bloße Auge	Stellen Sie sicher, dass Schrauben vorhanden sind (falls vorhanden)
		Schaden	Das bloße Auge	Die Freilegung von Rissen im Inneren ist nicht zulässig
	Linse	Kratzen	Das bloße Auge	Keine Auswirkung auf den Auflösungsstandard
		Kontamination	Das bloße Auge	Keine Auswirkung auf den Auflösungsstandard
		Ölfilm	Das bloße Auge	Keine Auswirkung auf den Auflösungsstandard
		Abdeckband	Das bloße Auge	Kein Problem beim Aussehen.
	Funktion	Bild	Keine Kommunikation	Testboard
Helles Pixel			Tafel	Im Image Center nicht erlaubt
Dunkles Pixel			Weißer Tafel	Im Image Center nicht erlaubt
Verschwommen			Das bloße Auge	Nicht erlaubt
Kein Bild			Das bloße Auge	Nicht erlaubt
Vertikale Linie			Das bloße Auge	Nicht erlaubt
Horizontale Linie			Das bloße Auge	Nicht erlaubt
Kleines Leck			Das bloße Auge	Nicht erlaubt
Blinkendes Bild			Das bloße Auge	Nicht erlaubt
Prellung			Inspektionslehre	Nicht erlaubt
Auflösung			Diagramm	Folgt dem Diagrammstandard für ausgehende Inspektionen
Farbe			Das bloße Auge	Kein Problem
Lärm			Das bloße Auge	Nicht erlaubt
Ecke dunkel			Das bloße Auge	Weniger als 100 x 100 Pixel
Farbauflösung			Das bloße Auge	Kein Problem
Abmessungen	Höhe	Das bloße Auge	Befolgt Zulassungsdatenblatt	
	Breite	Das bloße Auge	Befolgt Zulassungsdatenblatt	
	Länge	Das bloße Auge	Befolgt Zulassungsdatenblatt	
	Gesamt	Das bloße Auge	Befolgt Zulassungsdatenblatt	

YDSCAM Paketlösungen

YDSCAM Kameramodul



Komplett mit Linsenschutzfolie



Tablett mit Gitter und Raum



Legen Sie die Kameras auf das Tablett



YDSCAM Paketlösungen

Volles Fach mit Kameras

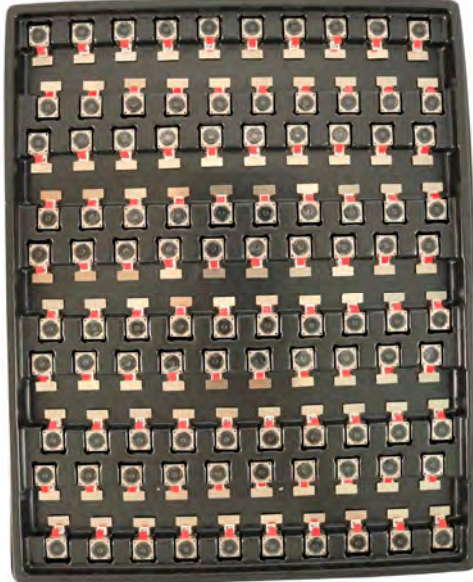

Decken Sie das Tablett mit dem Deckel ab

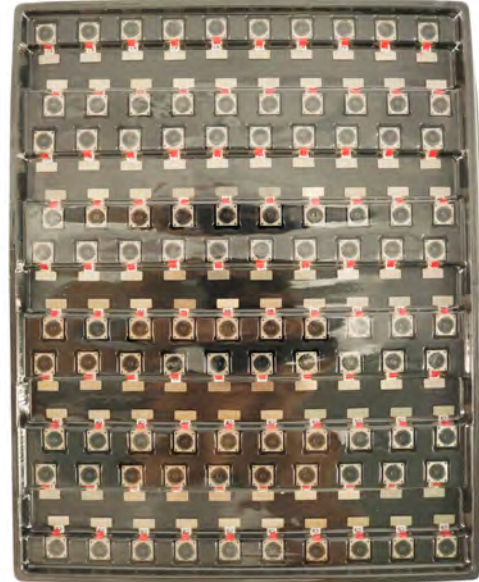

Legen Sie das Tablett in den antistatischen Beutel



Staubsaugen Sie den antistatischen Beutel



YDSCAM Paketlösungen

Versiegelter antistatischer Vakuumbbeutel mit Etiketten

1. Modell und Beschreibung 2. Menge 3. Herstellungsdatumscode 4. Achtung



YDSCAM Paketlösungen

Legen Sie Schaumstoffplatten zwischen die Tablettbeutel



Schaumstoffplatten sind größer als Tablett



Legen Sie Schaumstoffplatten und Tablett in den Karton



Die Schaumstoffplatten sitzen fest im Karton



Verschließen Sie die Carbon Box



Beschriften Sie den Carbon-Versandkarton



YDSCAM Paketlösungen

USB-Kameramodul

Komplett mit Objektivschutzfolie

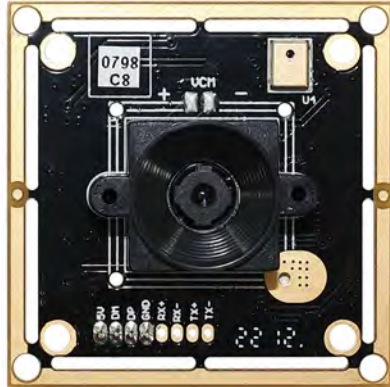

Legen Sie die Kameraprobe in den antistatischen Beutel

Legen Sie USB-Kameras in das Fach



Verschließen Sie das Tablett mit einem antistatischen Beutel

Beschriften Sie den Carbon-Versandkarton



YDSCAM Paketlösungen

Legen Sie die Kameraprobe in den antistatischen Beutel



Legen Sie die Steckverbinder in den antistatischen Beutel



Beschriften Sie die Probenbeutel



Stecken Sie die Steckverbinder in die Spule



Legen Sie Proben in die Carbonbox



Stecken Sie die Steckverbinder in die Carbonbox





Firma YDSCAM

YingDeShun Co. Ltd. (YDS) wurde 2017 gegründet, ein technologieorientierter Hersteller der nächsten Generation, der sich auf Forschung, Design und Produktion von Audio- und Videoprodukten spezialisiert hat. YDS verfügt über 20.000 Quadratmeter große automatisierte Anlagen mit 100 Mitarbeitern und einem Jahresdurchsatz von 30.000.000 Kameraeinheiten.

YDS bietet OEM- und ODM-Design sowie Auftragsfertigung und baut die Kameraprodukte. Sie können uns die Anforderungen mitteilen, sogar mit einem Handentwurf. Unser Vertrieb und unsere Technik arbeiten zusammen, um Ihre Anforderungen zu erfüllen. Wir verstehen uns als Ihr langfristiger Partner bei der Entwicklung praktischer und innovativer Lösungen.

Unser Team deckt alles von der ersten Konzeptentwicklung bis zum Massenprodukt ab. YDS ist auf kundenspezifisches Kameradesign, Rohmaterial, Elektroniktechnik, Firmware-/Softwareentwicklung, Produkttests und Verpackungsdesign spezialisiert. Unsere erfahrenen strategischen Liefersysteme bieten eine robuste und zuverlässige Fertigungskapazität für Aufträge unterschiedlicher Größe.



Eingeschränkte Garantie

YDS gewährt die folgende eingeschränkte Garantie, wenn Sie das/die Produkt(e) direkt von der YDS-Firma oder über die YDS-Website www.YDSCAM.com erworben haben. Von anderen Verkäufern oder Quellen gekaufte Produkte fallen nicht unter diese eingeschränkte Garantie. YDS garantiert, dass die Produkte bei normalem Gebrauch für einen Zeitraum von einem (1) Jahr ab dem Datum, an dem Sie das Produkt erhalten („Garanzzeitraum“), frei von Material- und Verarbeitungsfehlern sind.

Für alle Produkte, die während der Garanzzeit wesentliche Material- oder Verarbeitungsfehler aufweisen oder entwickeln, wird YDS nach eigenem Ermessen entweder: (i) das/die Produkt(e) reparieren; (ii) das/die Produkt(e) durch ein/e neue oder generalüberholte(n) Produkt(e) ersetzen (wobei das/die Ersatzprodukt(e) vom identischen Modell oder einer gleichwertigen Funktion sein müssen); oder (iii) Ihnen eine Rückerstattung des Preises gewähren, den Sie für das/die Produkt(e) bezahlt haben.

Diese eingeschränkte Garantie von YDS beschränkt sich ausschließlich auf Reparatur und/oder Ersatz gemäß den oben dargelegten Bedingungen. YDS ist nicht zuverlässig oder verantwortlich für etwaige Folgeereignisse.





YDS CAMERA MODULE

your best camera partner

Unsere Unternehmensstärke

Leistungsstarke Fabrik



Professioneller Service



Versprochene Lieferung



www.YDSCAM.com sales@ydscam.com Phone (WeChat, QQ): (+86) 177 2732 6718

All rights reserved @ YingDeShun Co. Ltd. Specifications subject to change without notice.